



**Fundación
Autismo Diario**

CONCIENCIA FONÉMICA



Susana París

PICTOGRAMAS DE ARASAAC

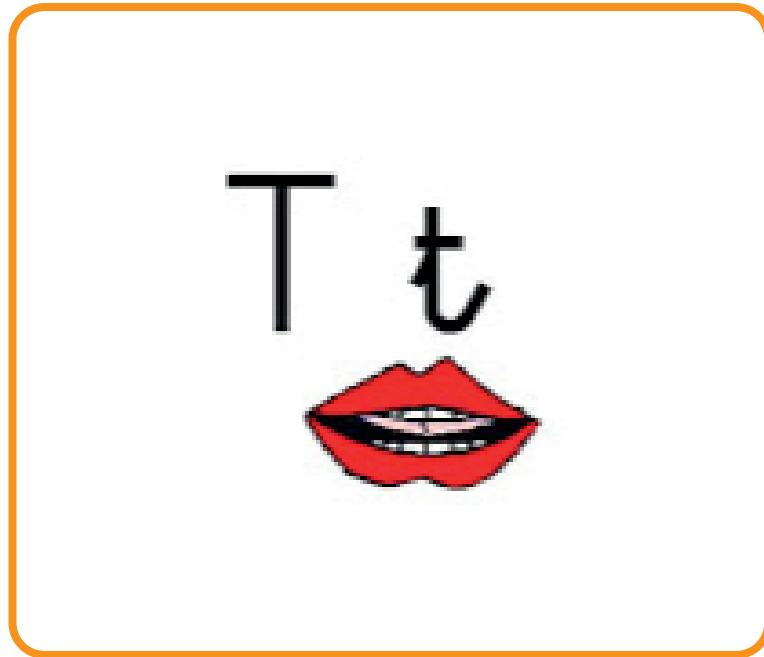

TA - TE - TI - TO - TU

CONCIENCIA FONÉMICA

T



BATIDO

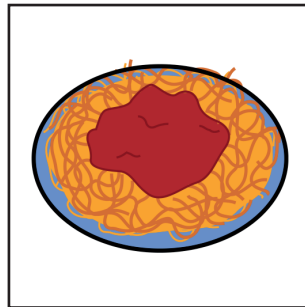

ESPAGUETTIS

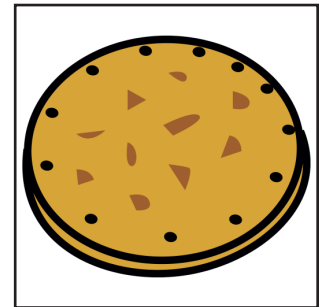

GALLETA



GUSANITOS

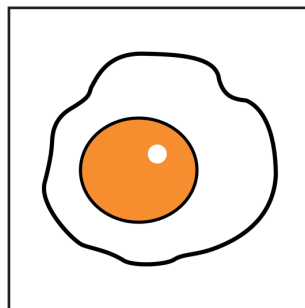

HUEVO FRITO

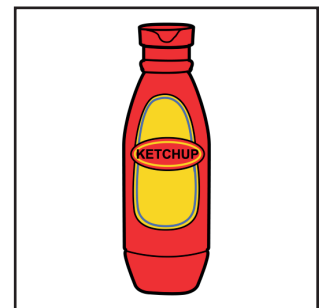

KETCHUP

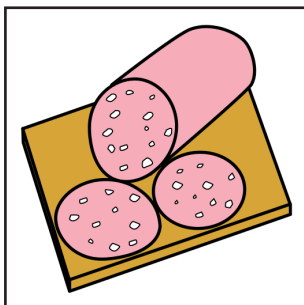

MORTADELA

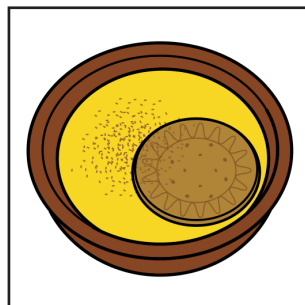

NATILLA



GANCHITOS



CONCIENCIA FONÉMICA

T

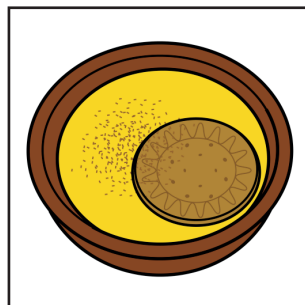
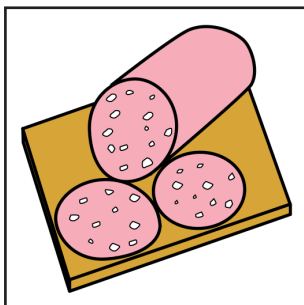
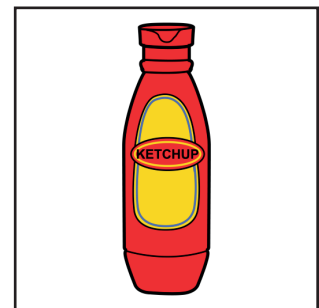
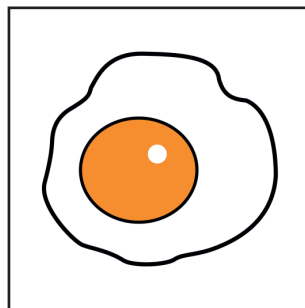
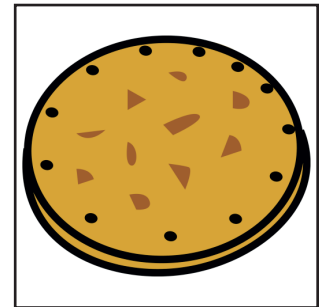
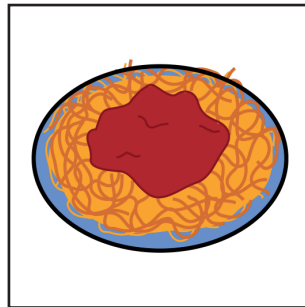

CONCIENCIA FONÉMICA

T

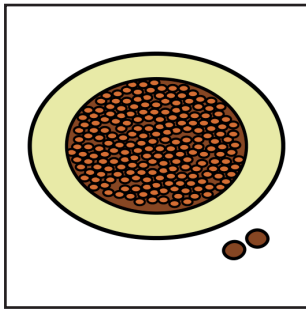

LENTEJAS

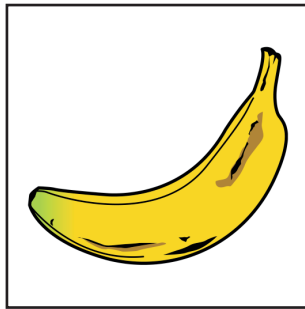

PLÁTANO



QUESITOS

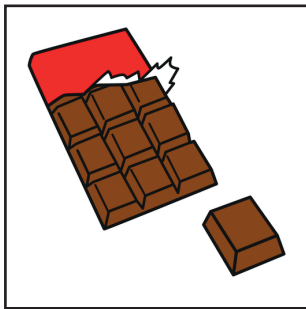

CHOCOLATE

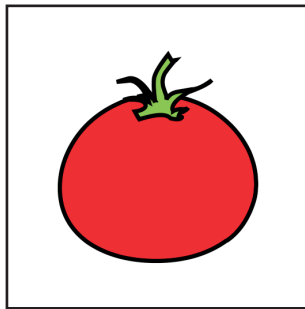

TOMATE

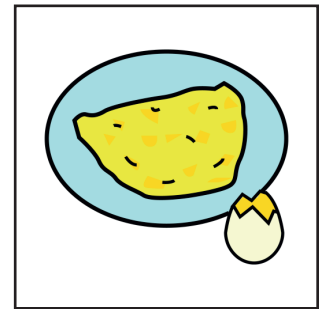

TORTILLA

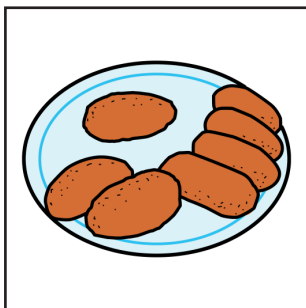

CROQUETAS

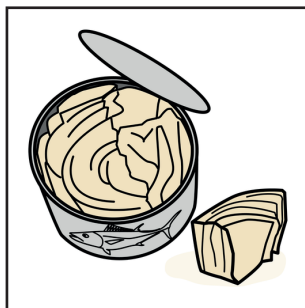

LATA DE ATÚN

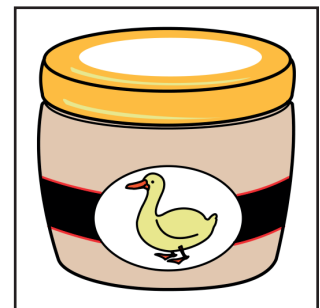

PATÉ



CONCIENCIA FONÉMICA

T

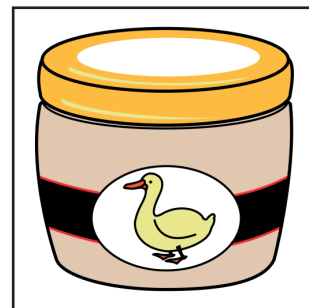
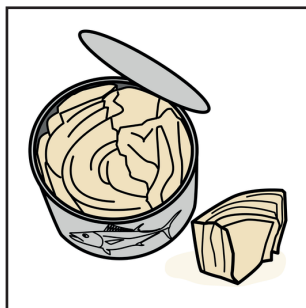
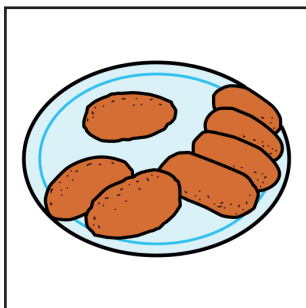
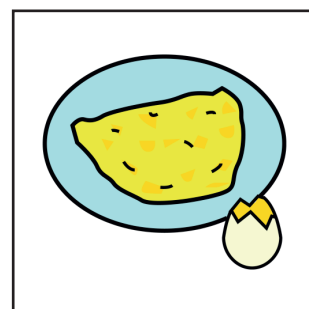
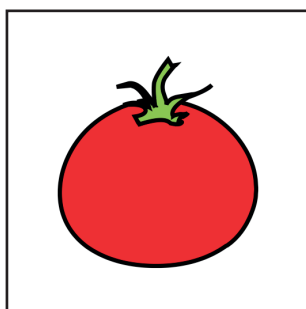
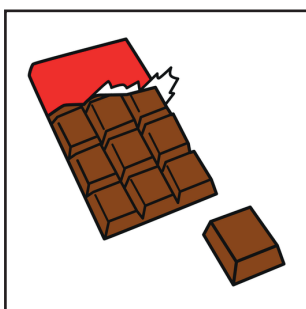
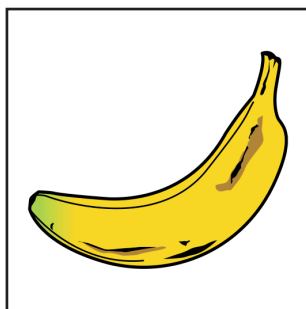
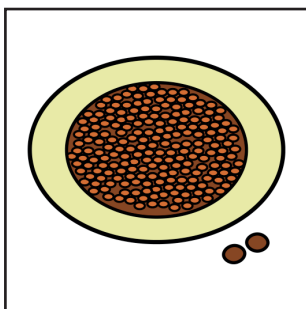

CONCIENCIA FONÉMICA

T

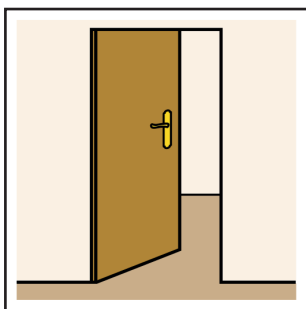

ABIERTO

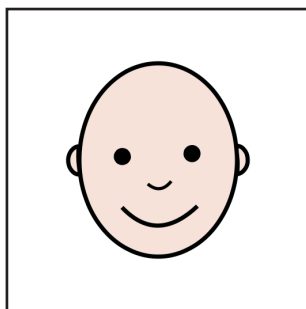

CONTENTO

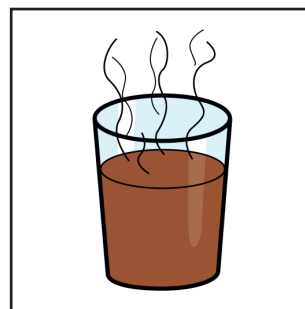

CALIENTE

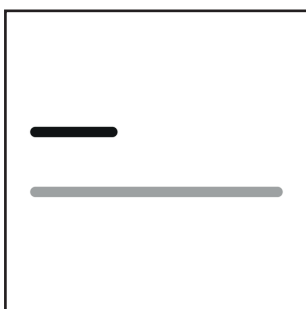

CORTO

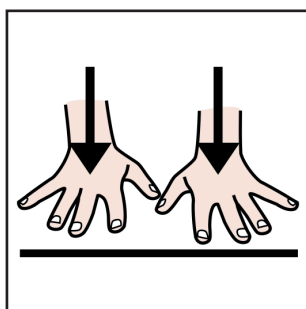

ESTAR

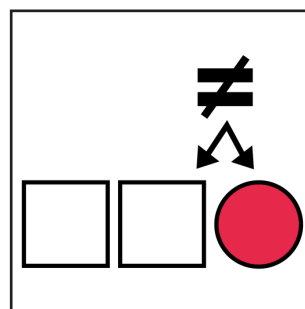

DIFERENTE

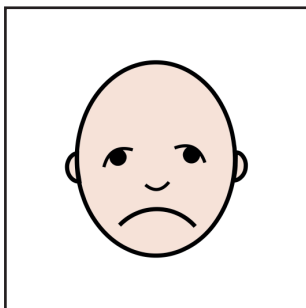

TRISTE

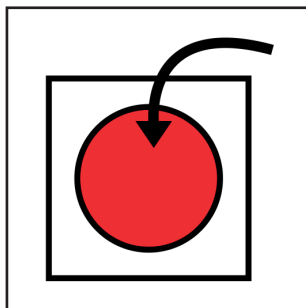

DENTRO

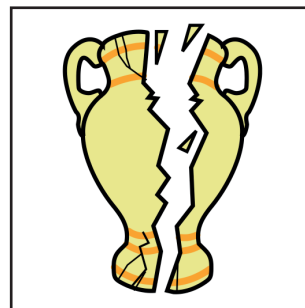

ROTO



CONCIENCIA FONÉMICA

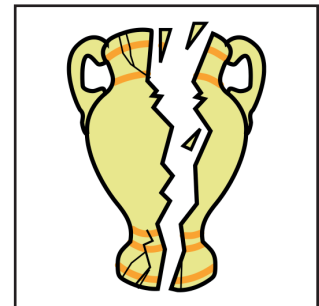
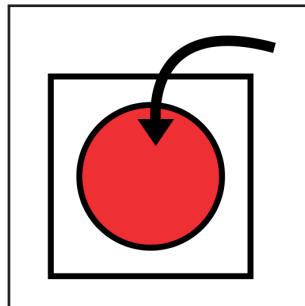
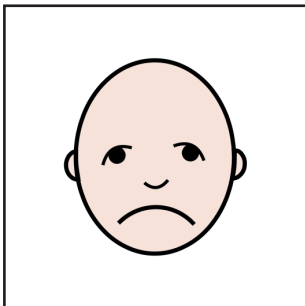
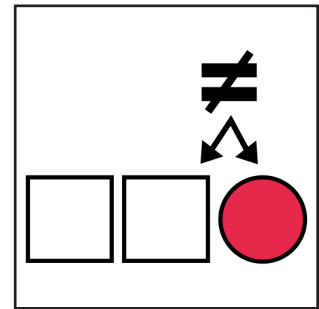
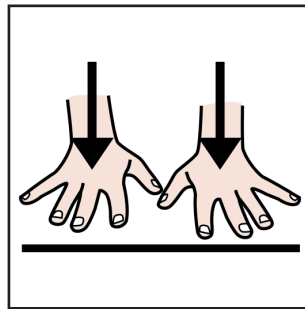
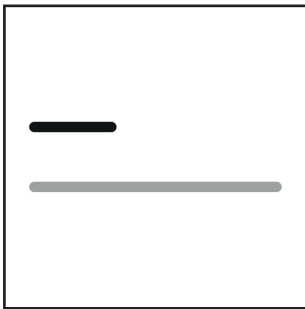
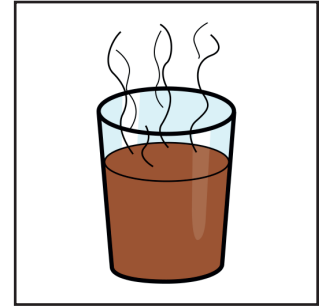
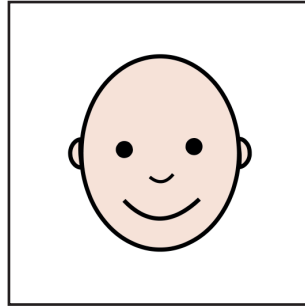
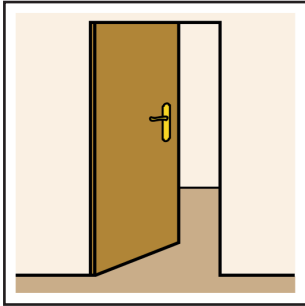

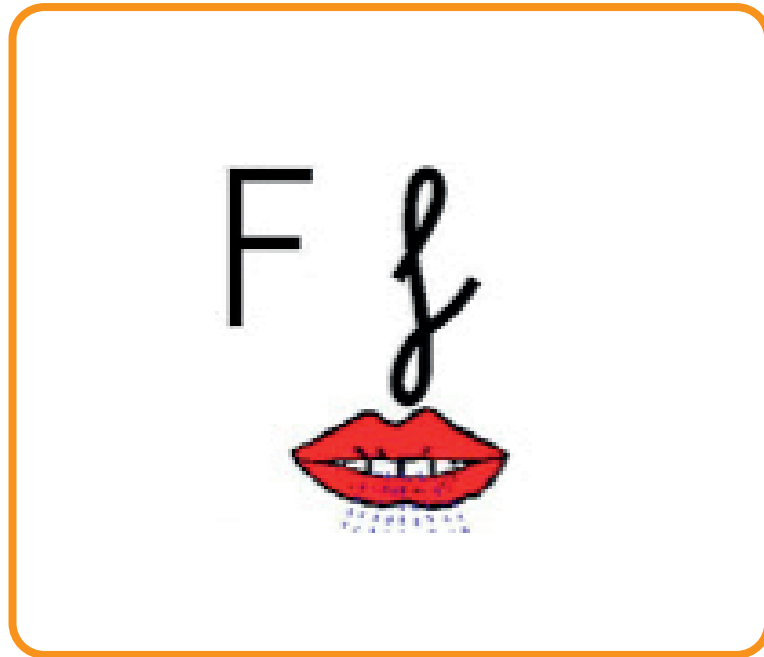

FA - FE - FI - FO - FU

CONCIENCIA FONÉMICA

F

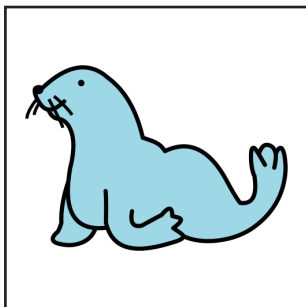

FOCA

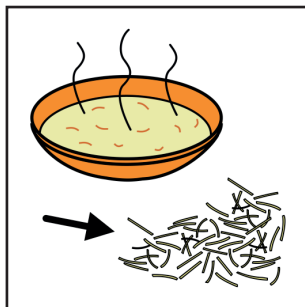

FIDEOS

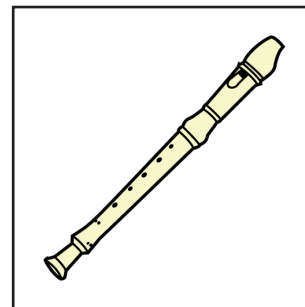

FLAUTA

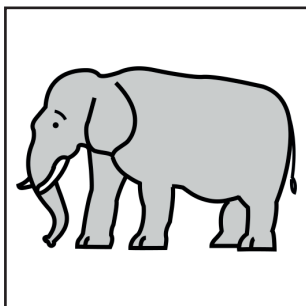

ELEFANTE

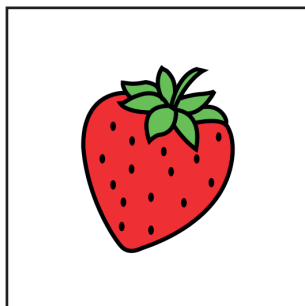

FRESA

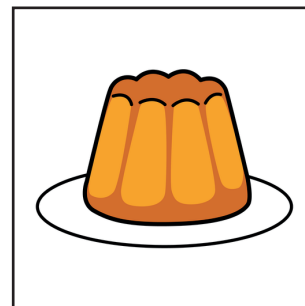

FLAN

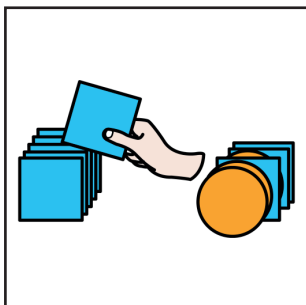

CLASIFICAR

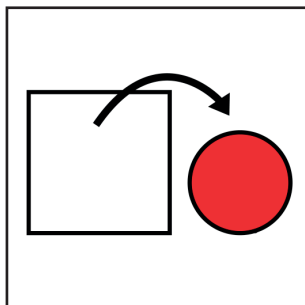

FUERA

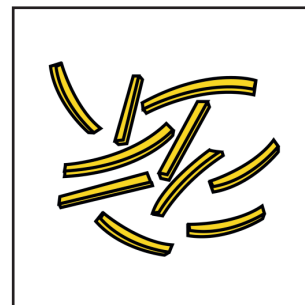

PATATAS
FRITAS



CONCIENCIA FONÉMICA

F

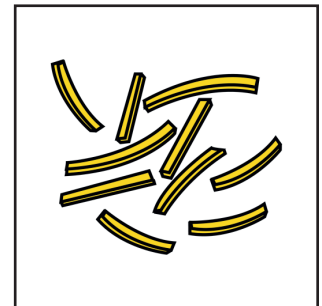
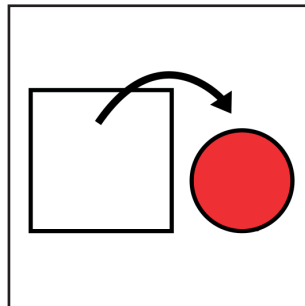
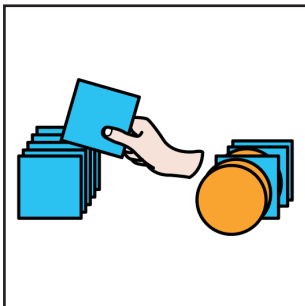
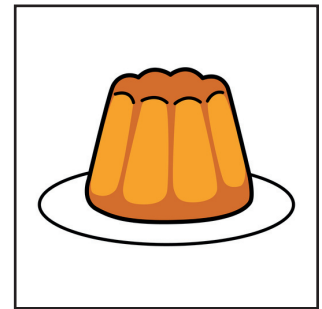
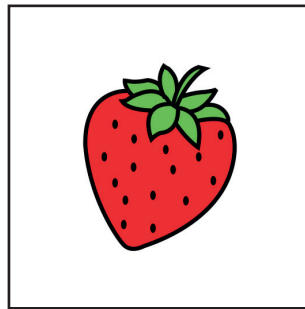
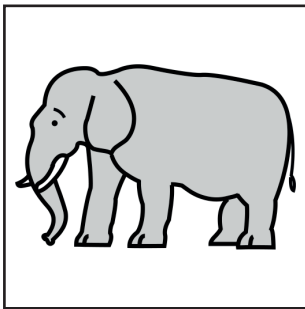
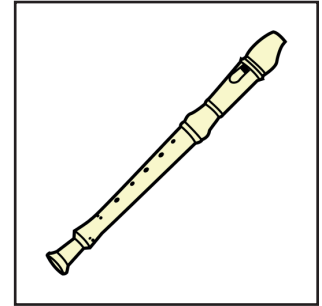
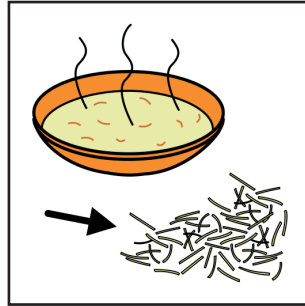
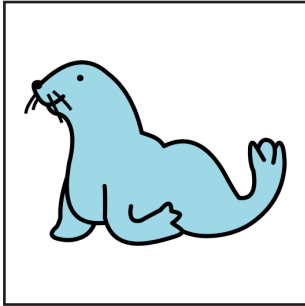

CONCIENCIA FONÉMICA

F

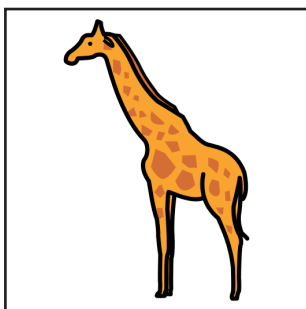

JIRAFRA

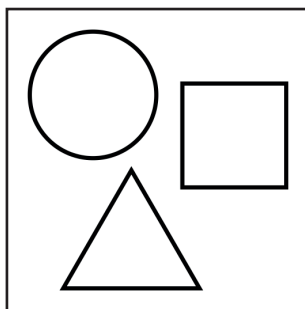

FORMAS

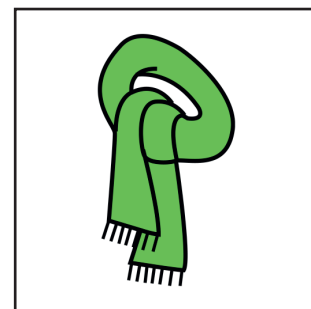

BUFANDA

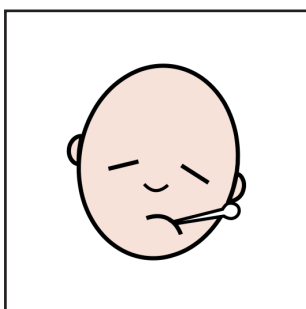

ENFERMO

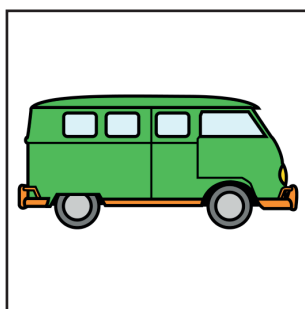

FURGONETA

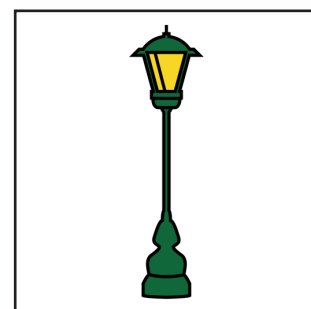

FAROLA

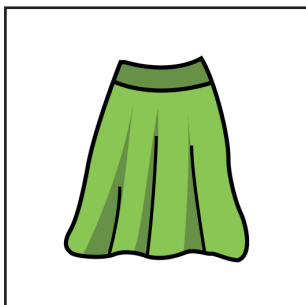

FALDA

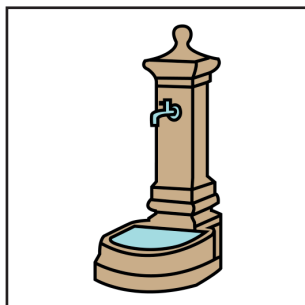

FUENTE

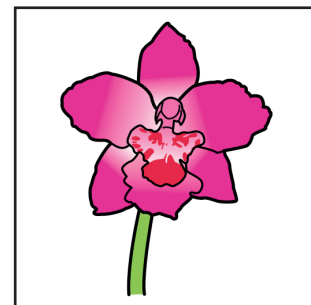

FLOR



CONCIENCIA FONÉMICA

F

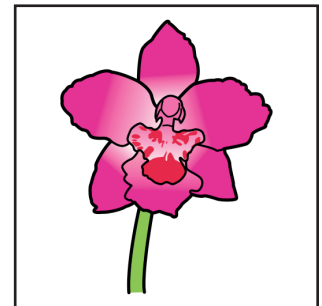
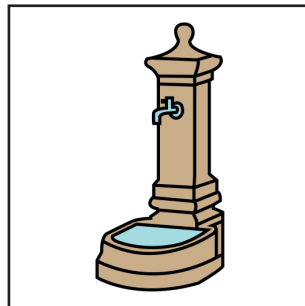
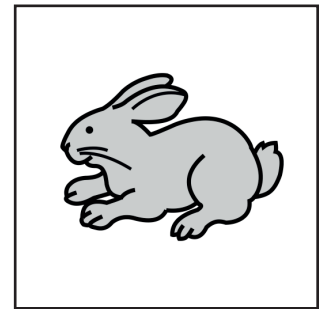
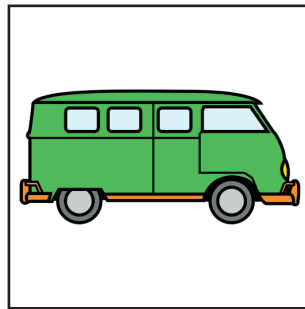
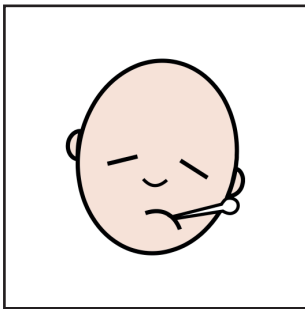
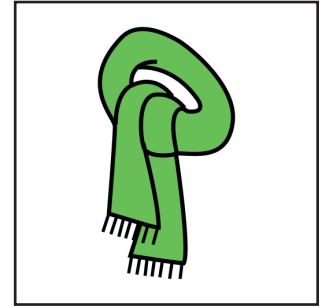
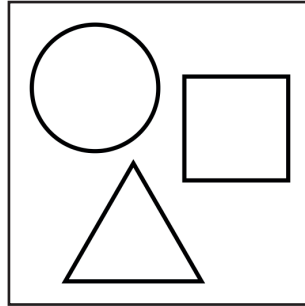
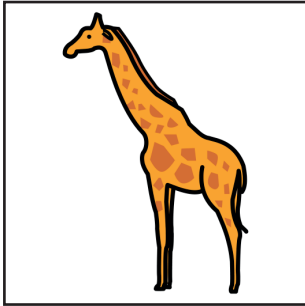

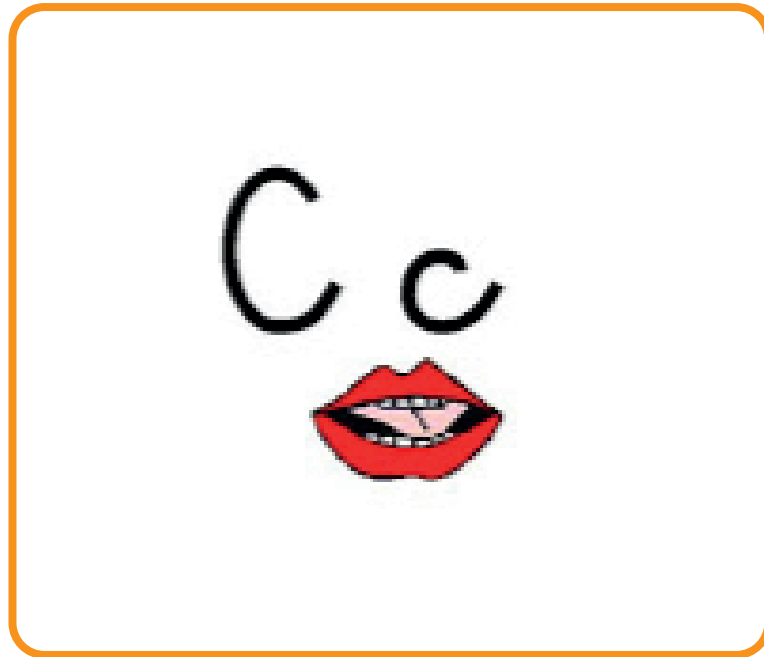

CE - CI

CONCIENCIA FONÉMICA

C

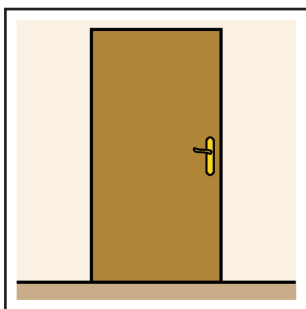

CERRADO

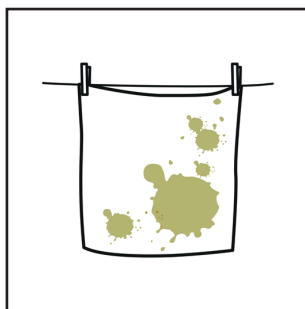

SUCIO

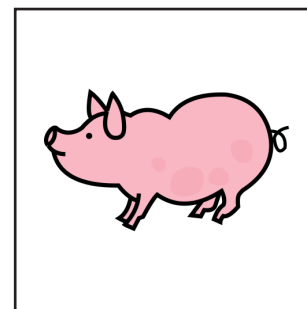

CERDO

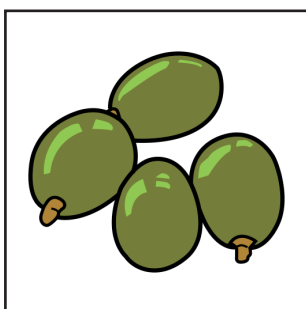

ACEITUNAS

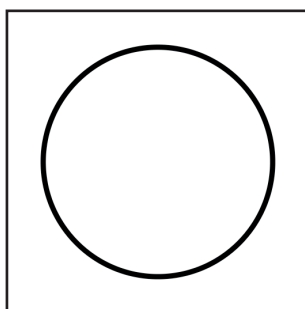

CÍRCULO



COCINA

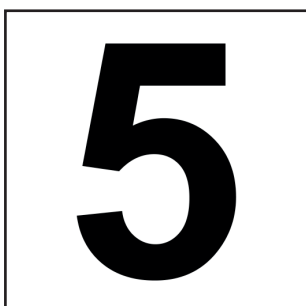

CINCO

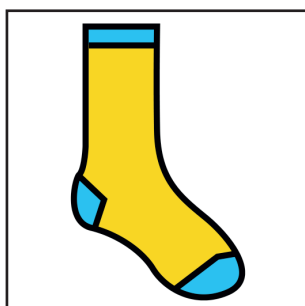

CALCETÍN

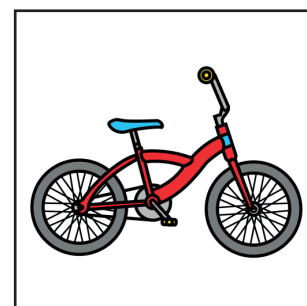

BICI



CONCIENCIA FONÉMICA

C

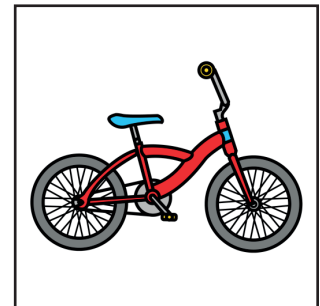
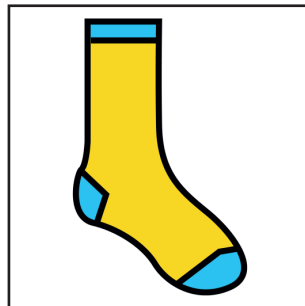
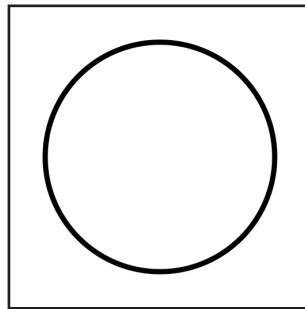
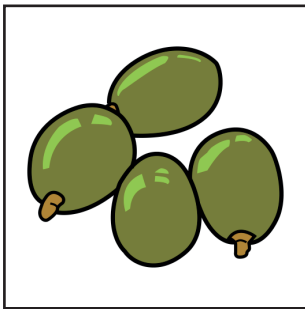
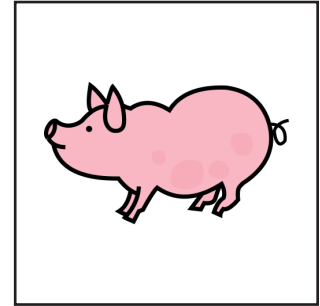
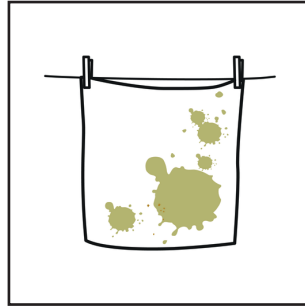
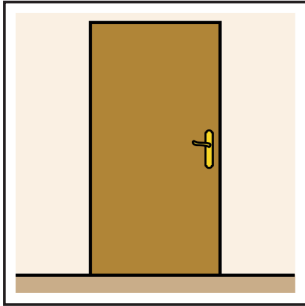



ZA - ZE - ZI - ZO - ZU

CONCIENCIA FONÉMICA

Z

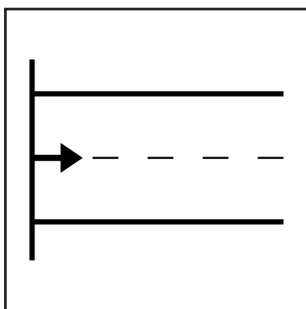

EMPEZAR

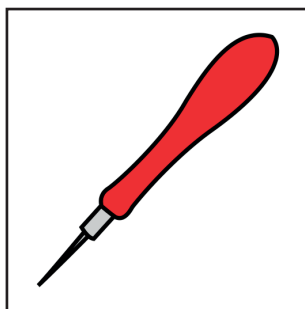

PUNZÓN



ZAMBOMBA

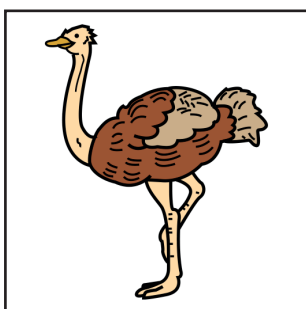

AVESTRUZ

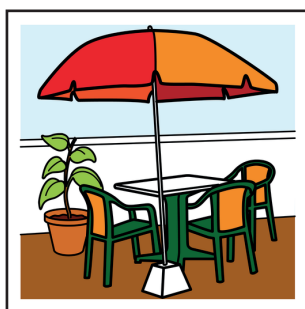

TERRAZA

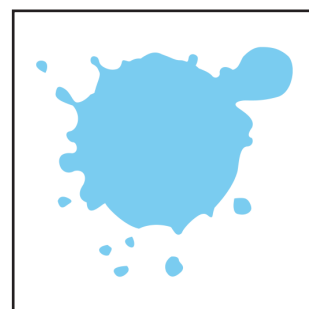

AZUL

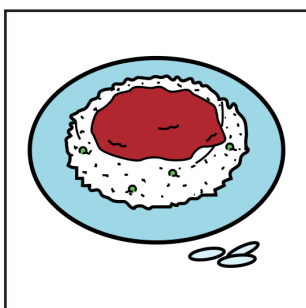

ARROZ

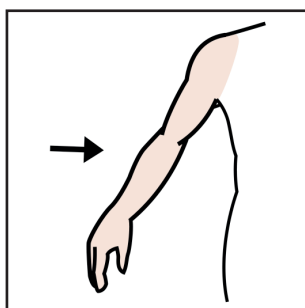

BRAZO

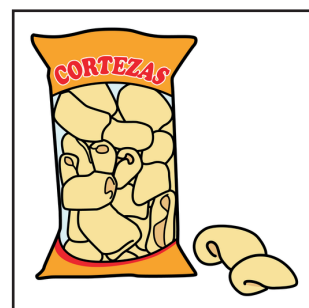

CORTEZAS



CONCIENCIA FONÉMICA

Z

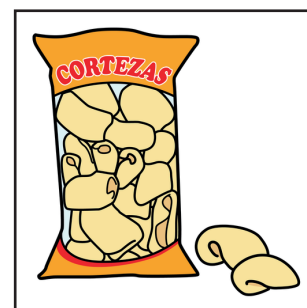
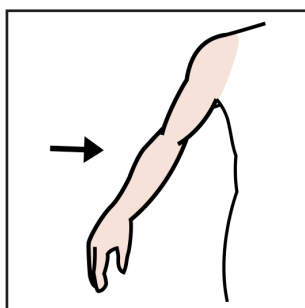
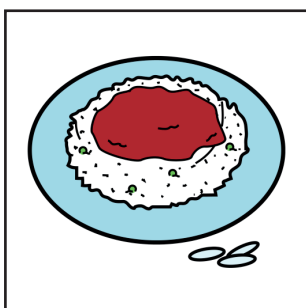
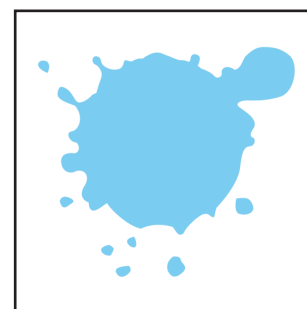
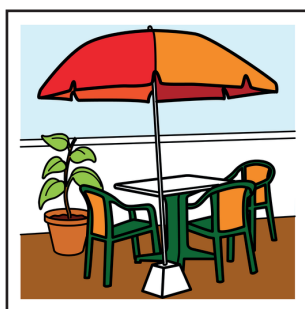
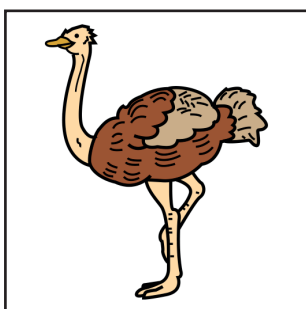
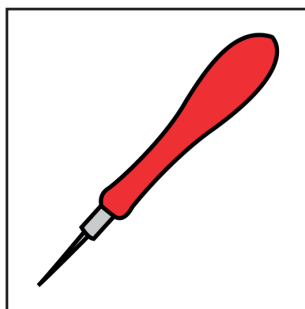
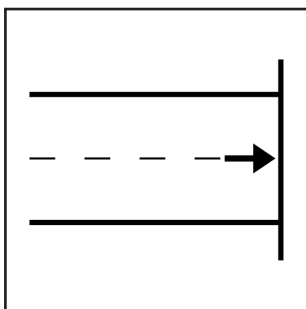

CONCIENCIA FONÉMICA

Z

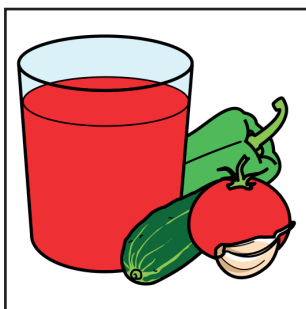

GAZPACHO

10

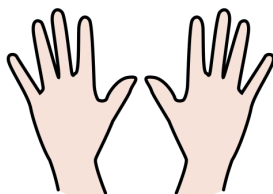

DIEZ



ZAPATOS



LIMPIEZA



ABRAZAR



CALABAZA



BOSTEZAR

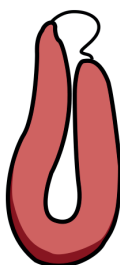

LONGANIZA



SONARSE
LA NARIZ



CONCIENCIA FONÉMICA

Z

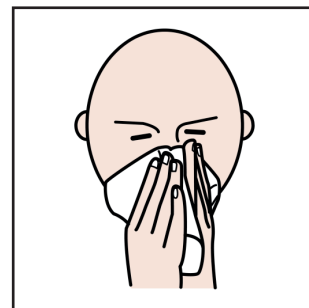
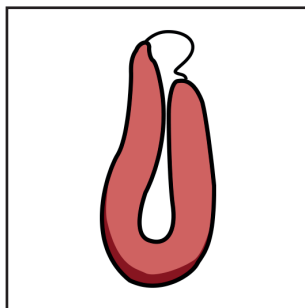
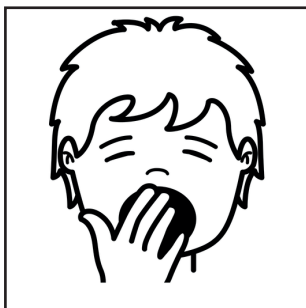
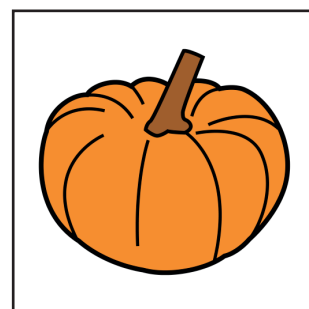
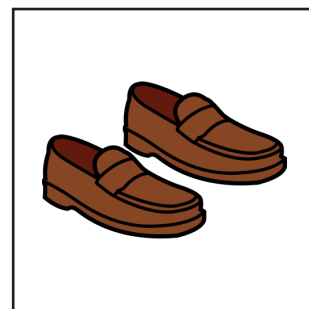
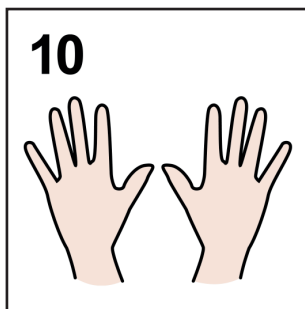
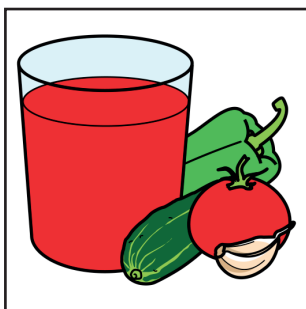



DA - DE - DI - DO - DU

CONCIENCIA FONÉMICA

D

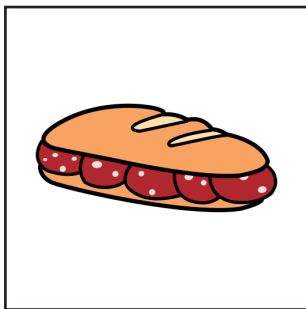

BOCADILLO

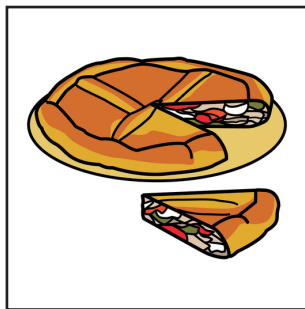

EMPANADA

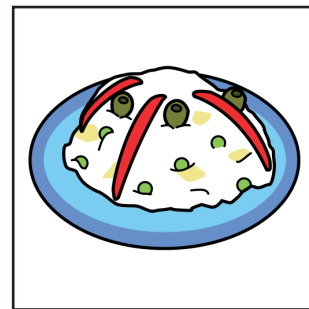

ENSALADILLA

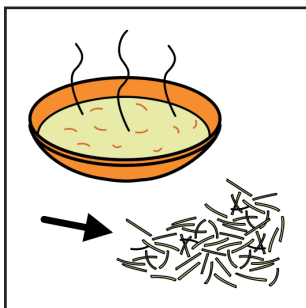

FIDEOS

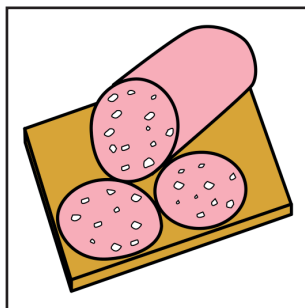

MORTADELA



ENSAIMADA

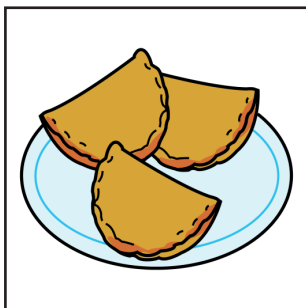

EMPANADILLAS

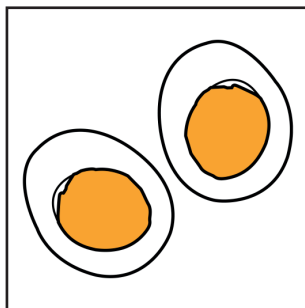

HUEVO
DURO

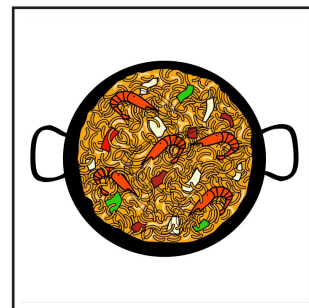

FIDEUÀ



CONCIENCIA FONÉMICA

D

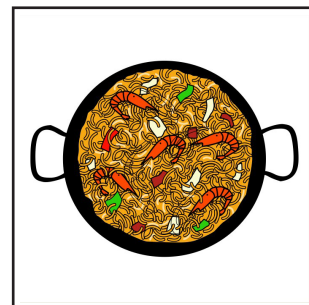
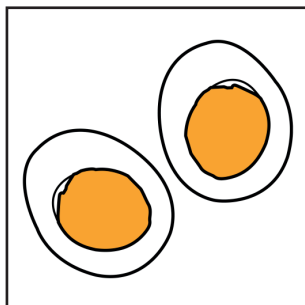
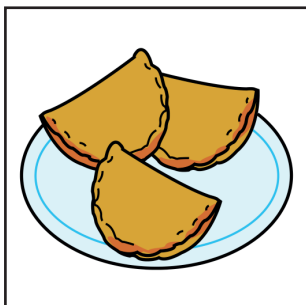
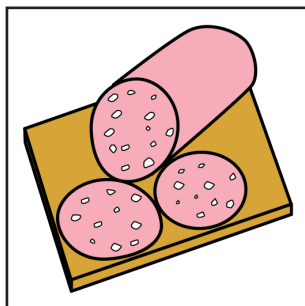
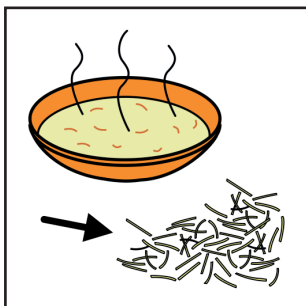
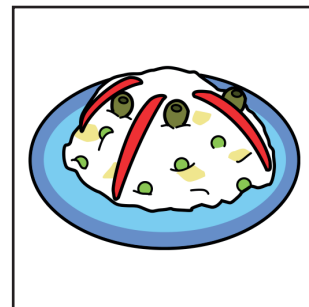
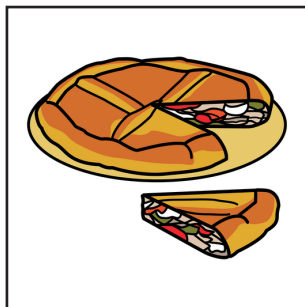
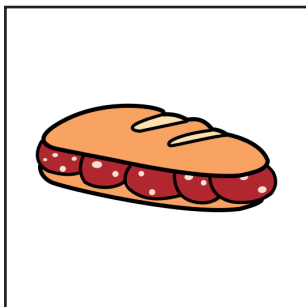

CONCIENCIA FONÉMICA

D



ADIÓS

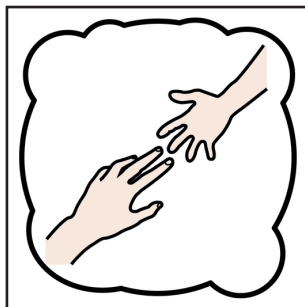

AYUDA

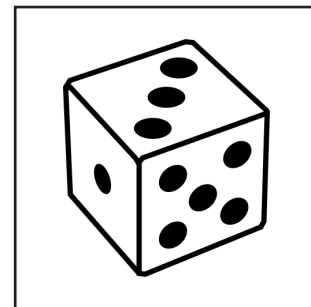

DADO

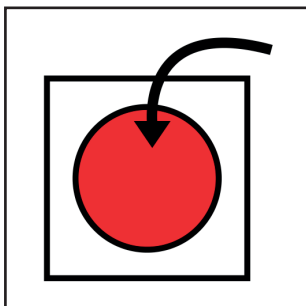

DENTRO

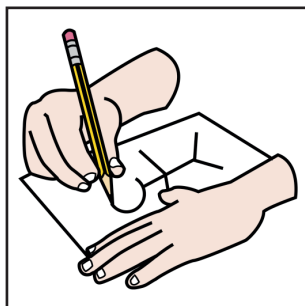

DIBUJAR

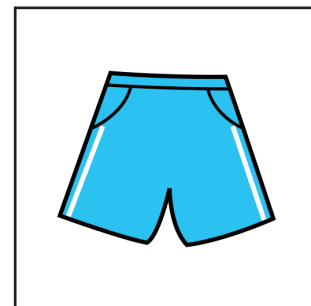

BAÑADOR

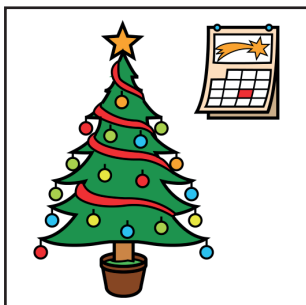

NAVIDAD

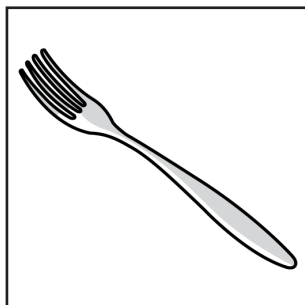

TENEDOR

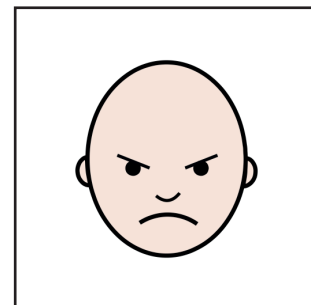

ENFADADO



CONCIENCIA FONÉMICA

D

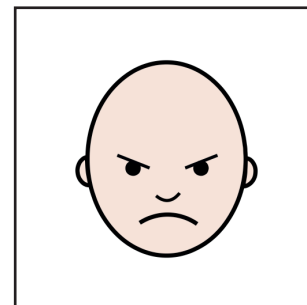
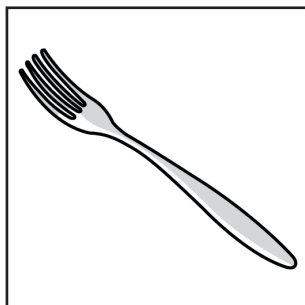
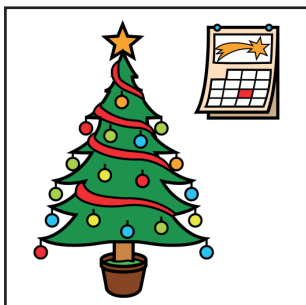
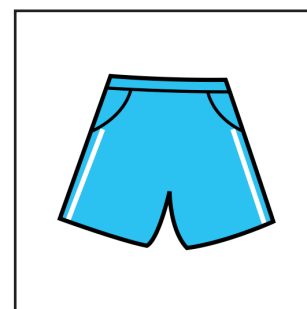
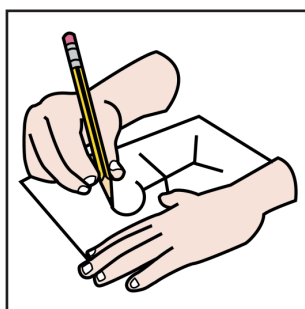
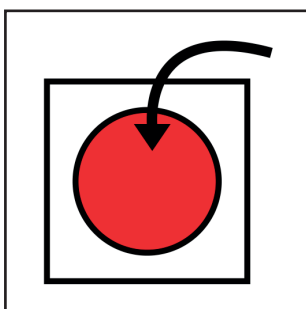
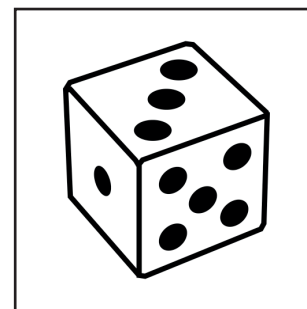
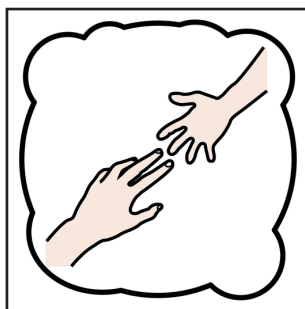

CONCIENCIA FONÉMICA

D

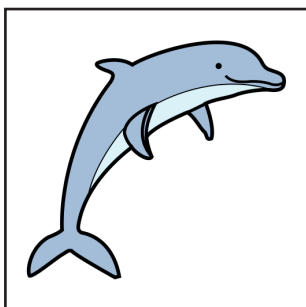

DELFIN

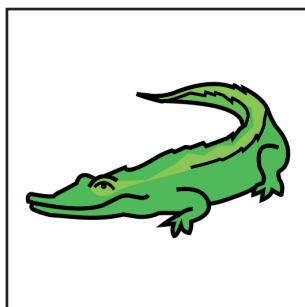

COCODRILO

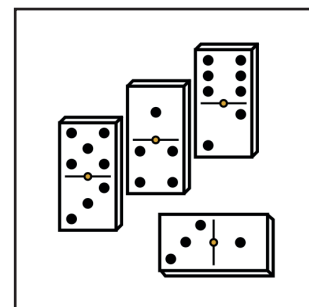

DOMINÓ

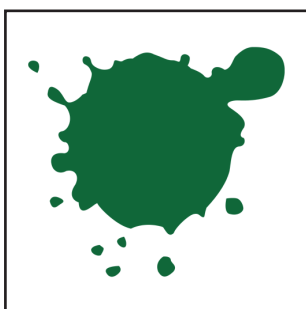

VERDE

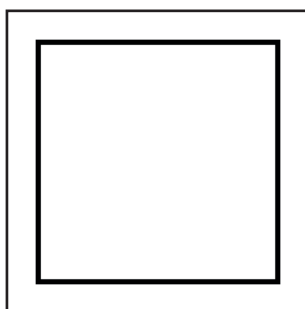

CUADRADO



ACORDEÓN

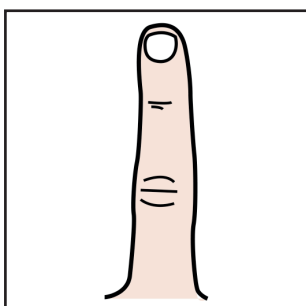

DEDO

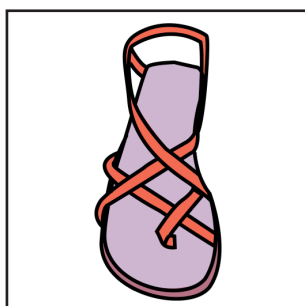

SANDALIA



DOS



CONCIENCIA FONÉMICA

D

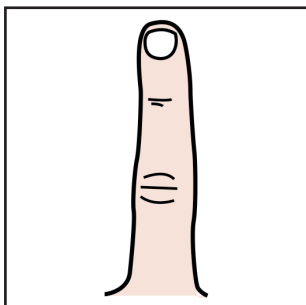
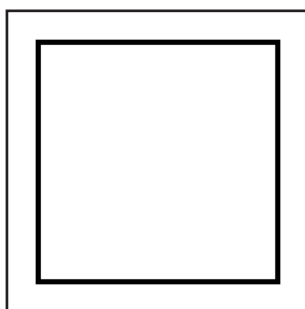
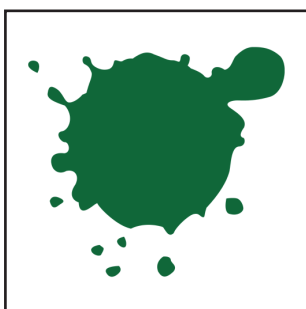
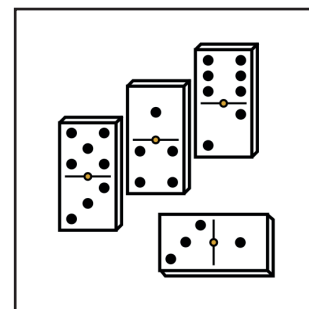
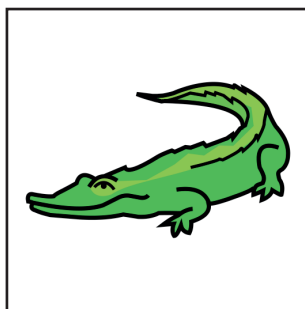
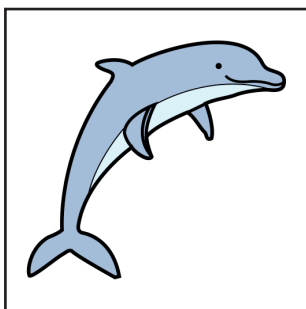

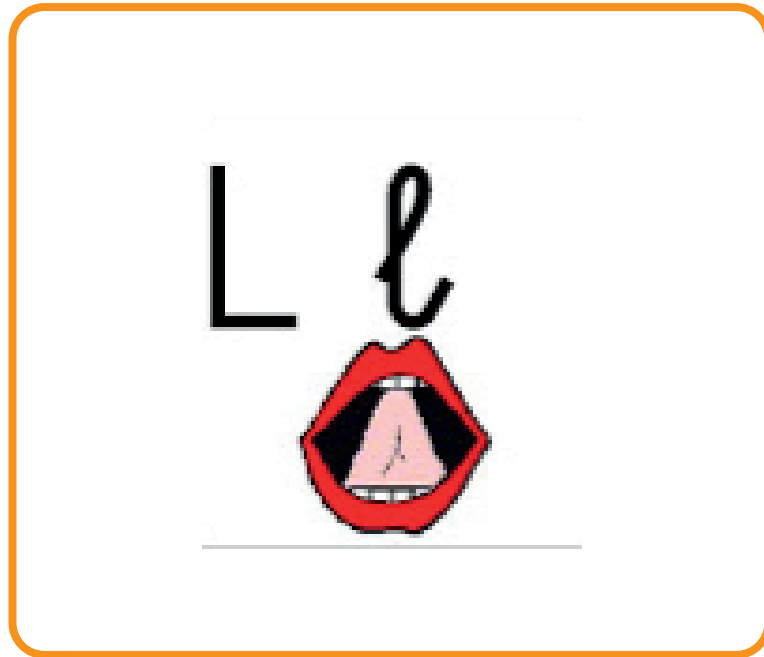

LA - LE - LI - LO - LU

CONCIENCIA FONÉMICA

L

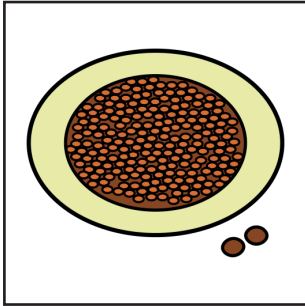

LENTEJAS

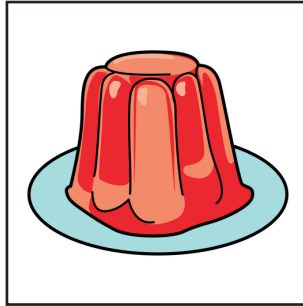

GELATINA

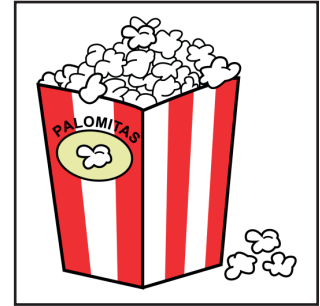

PALOMITAS

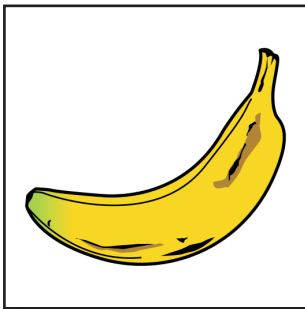

PLÁTANO

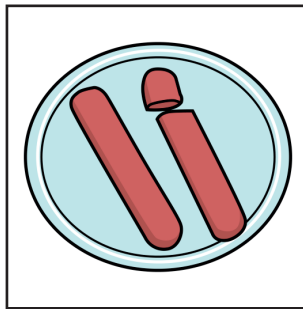

SALCHICHAS

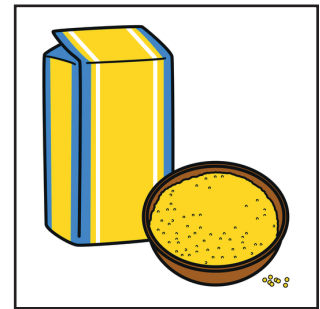

SÉMOLA

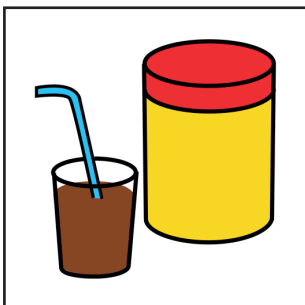

LECHE CON
CACAO

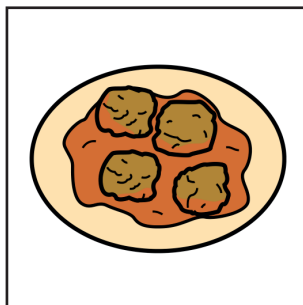

ALBÓNDIGAS

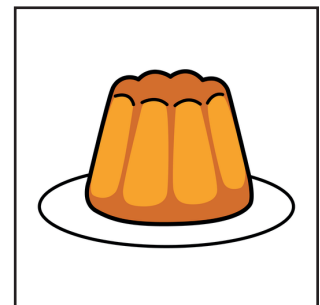

FLAN



CONCIENCIA FONÉMICA

L

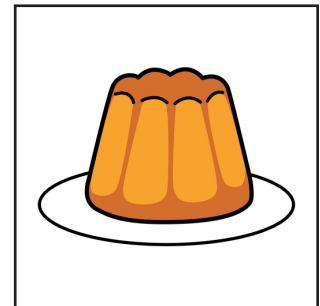
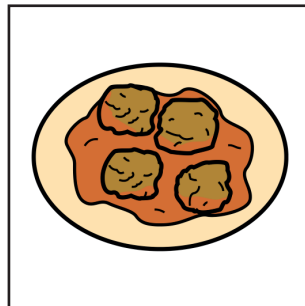
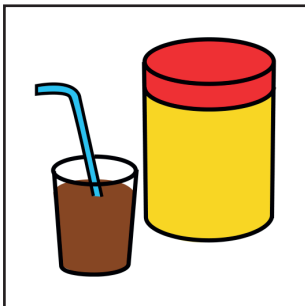
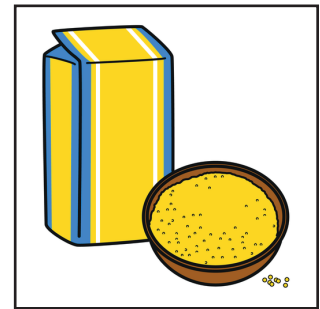
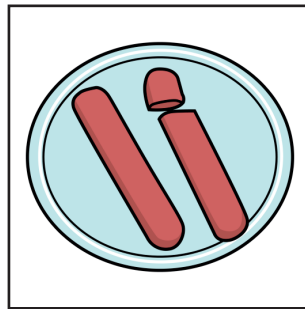
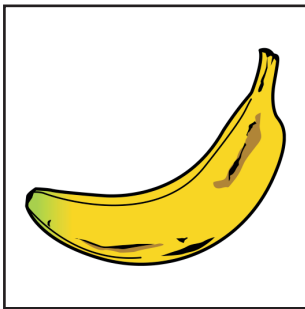
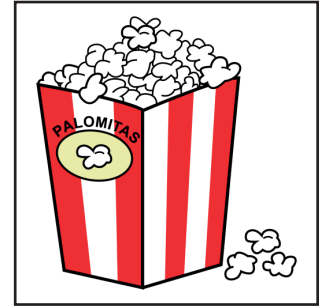
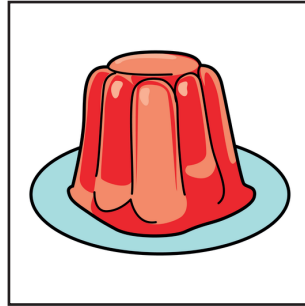
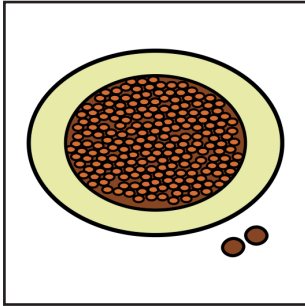

CONCIENCIA FONÉMICA

L

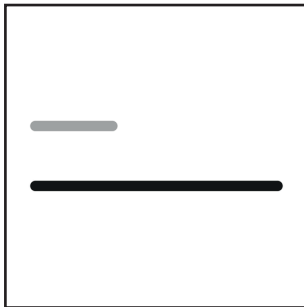

LARGO

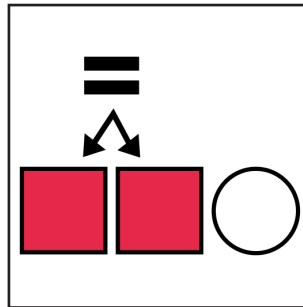

IGUAL

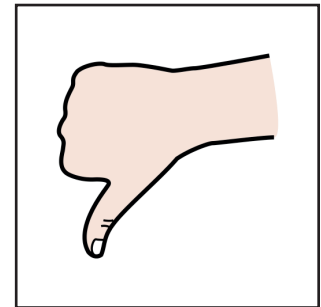

MAL

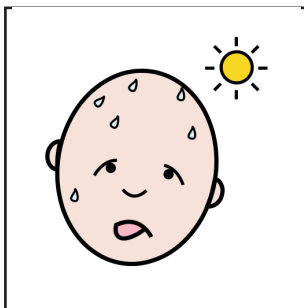

CALOR

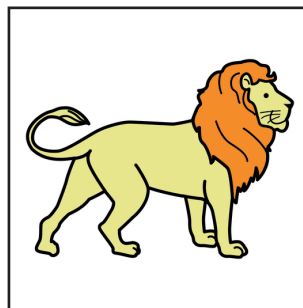

LEÓN

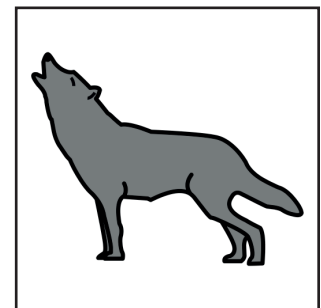

LOBO

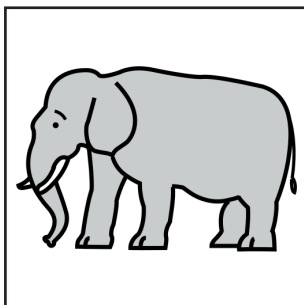

ELEFANTE

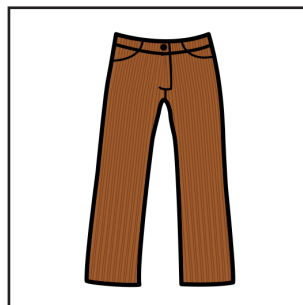

PANTALÓN

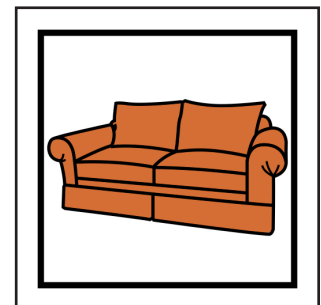

SALÓN



CONCIENCIA FONÉMICA

L

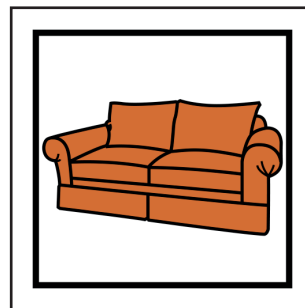
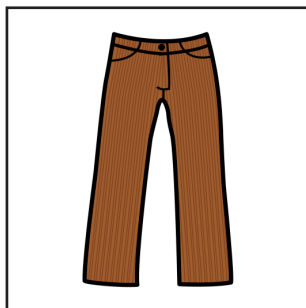
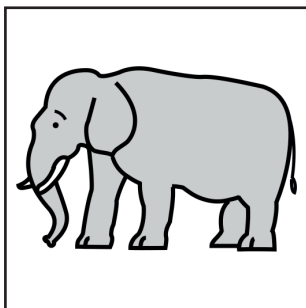
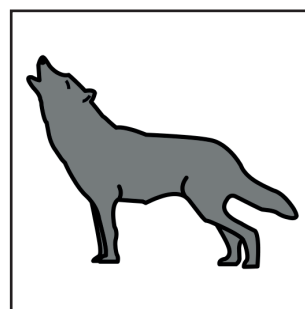
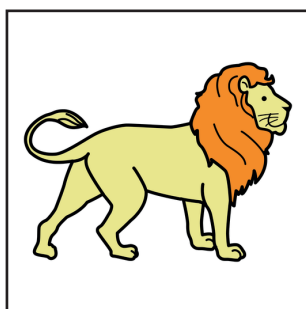
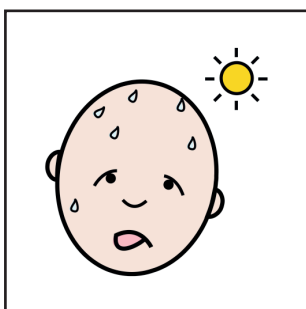
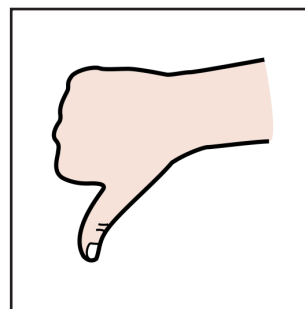
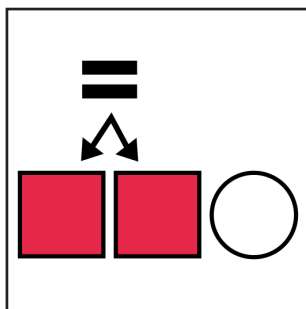
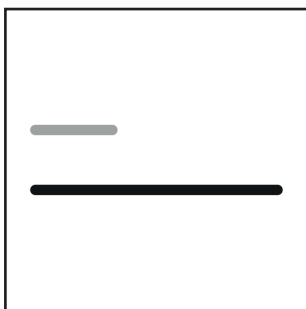

CONCIENCIA FONÉMICA

L

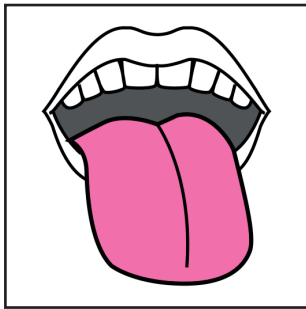

LENGUA

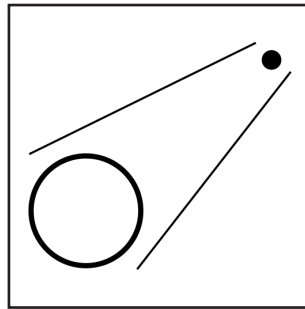

LEJOS

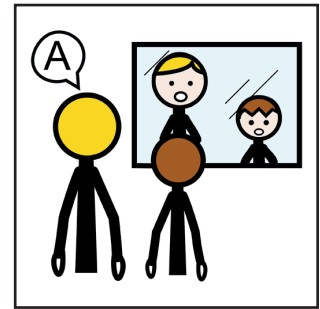

LOGOPEDIA

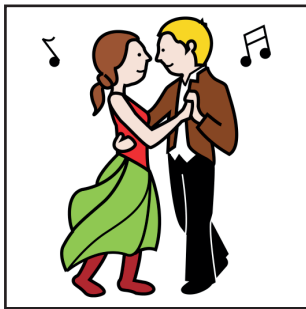

BAILAR

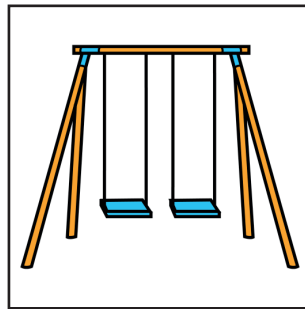

COLUMPIO

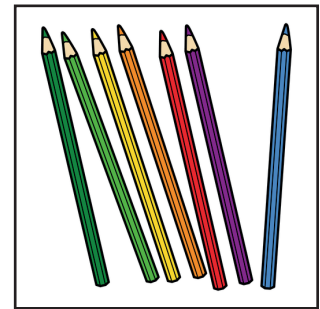

LÁPICES

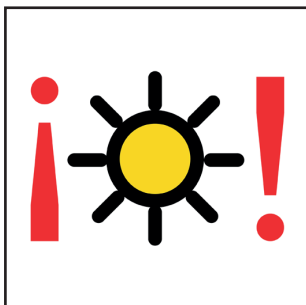

SOLEADO

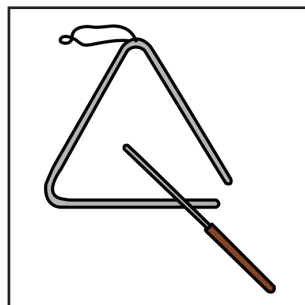

TRIÁNGULO

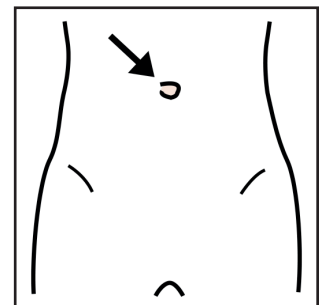

OMBLIGO



CONCIENCIA FONÉMICA

L

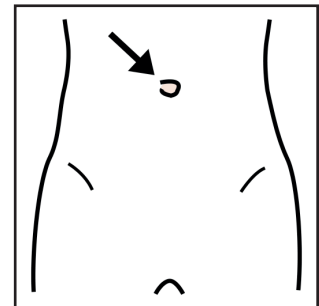
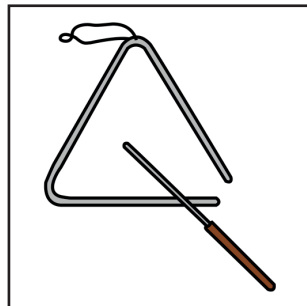
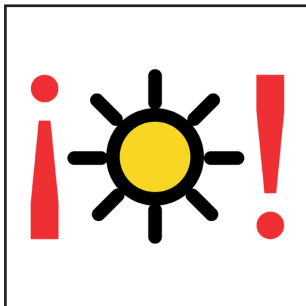
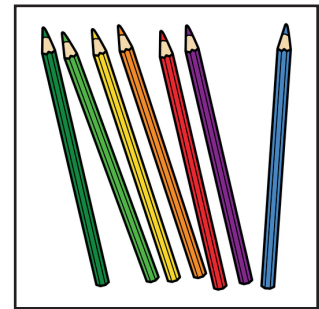
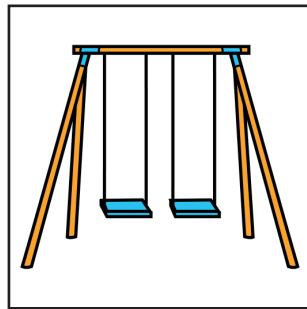
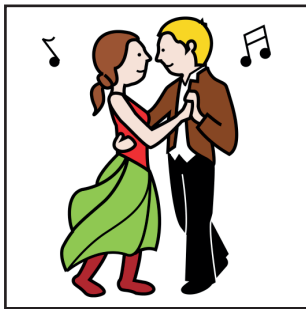
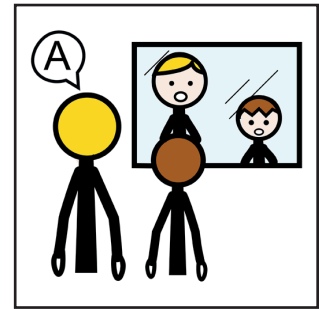
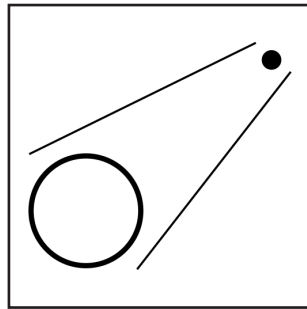
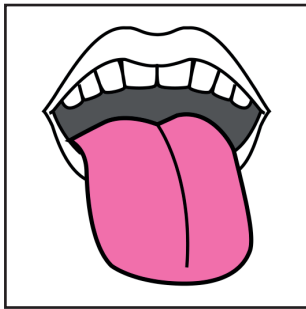

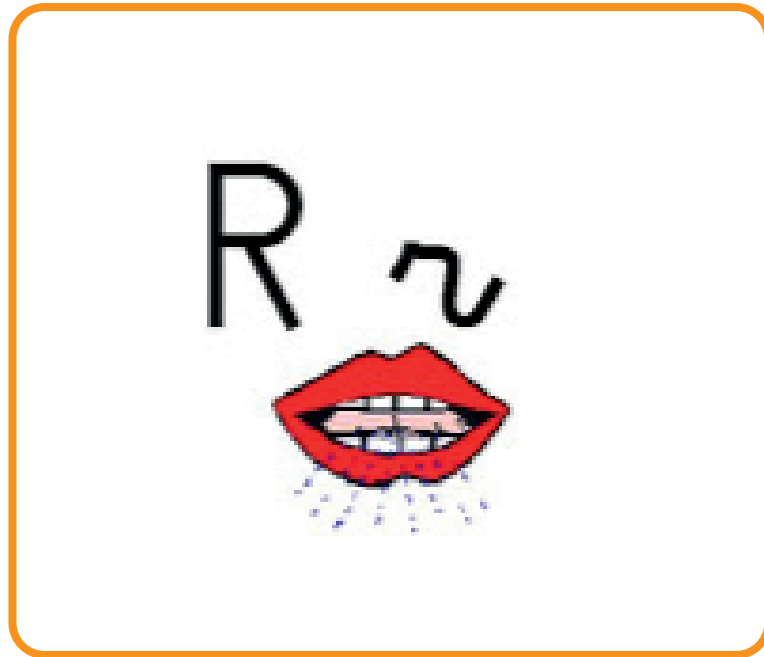

RA - RE - RI - RO - RU

-RRA, -RRE, -RRI, -RRO, -RRU

CONCIENCIA FONÉMICA

R

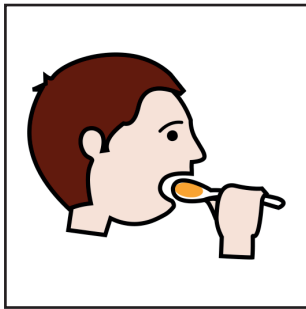

COMER

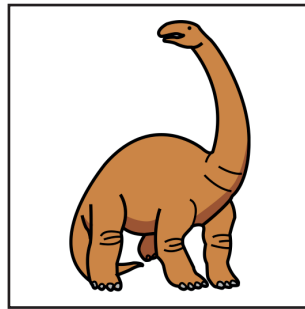

DINOSAURIO

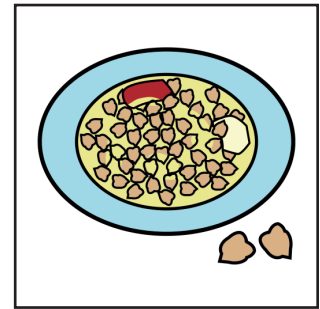

GARBANZOS

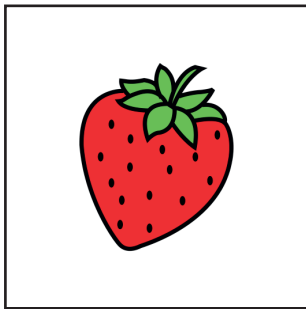

FRESA

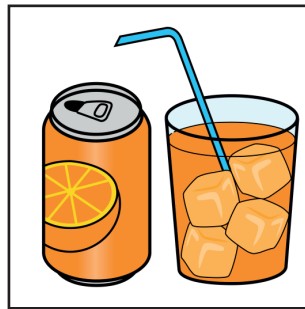

NARANJADA

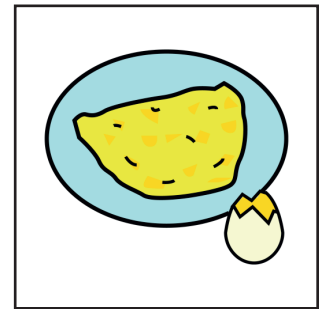

TORTILLA

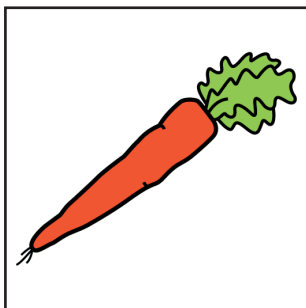

ZANAHORIA

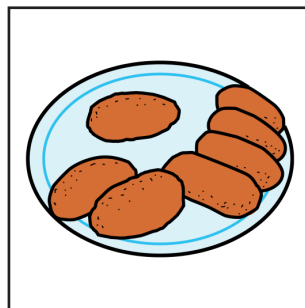

CROQUETAS

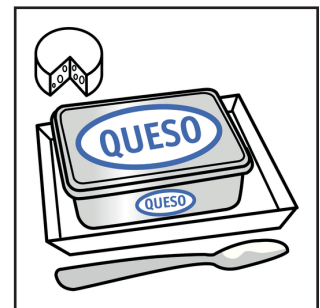

CREMA
DE QUESO



CONCIENCIA FONÉMICA

R

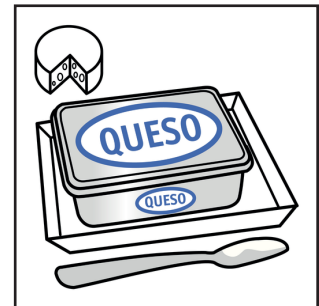
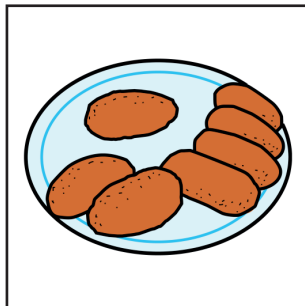
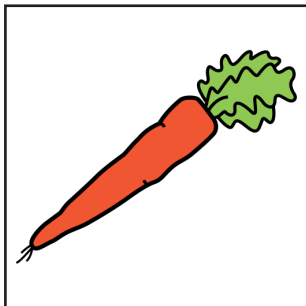
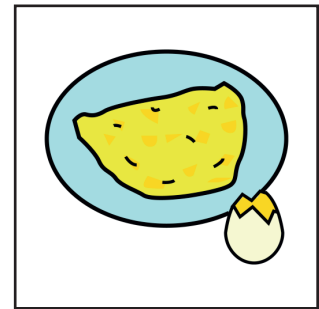
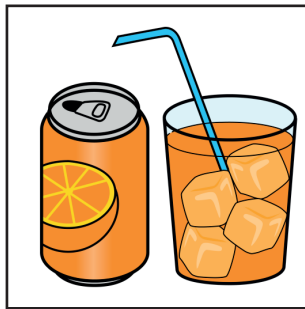
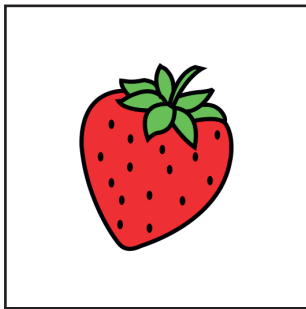
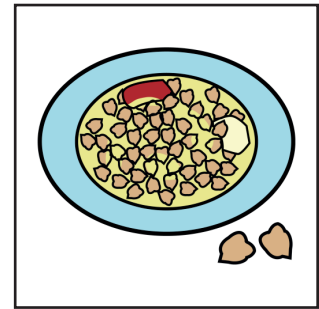
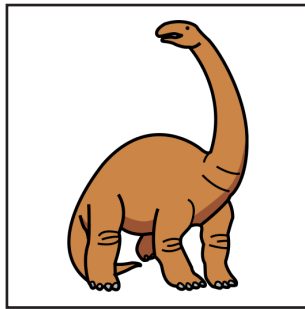
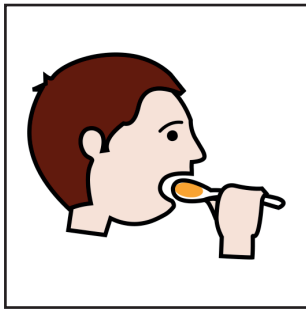

CONCIENCIA FONÉMICA

R

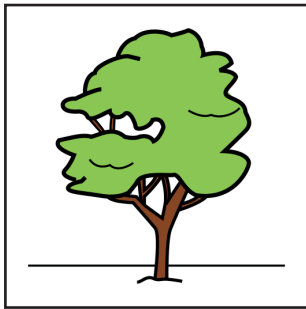

ÁRBOL



BESAR

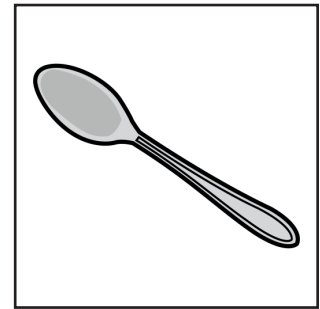

CUCHARA

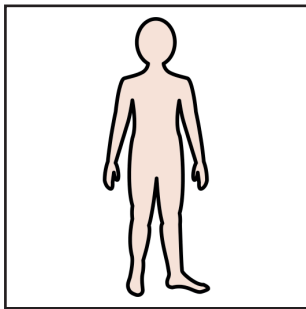

CUERPO

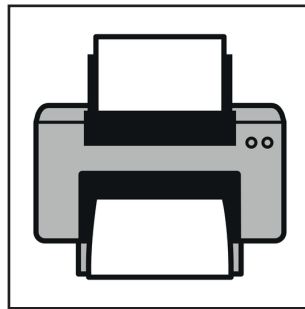

IMPRESORA

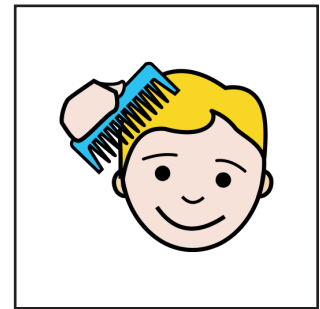

PEINARSE

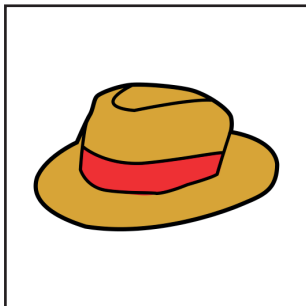

SOMBRERO

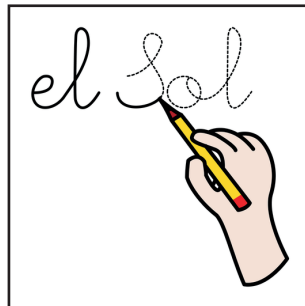

REPASAR

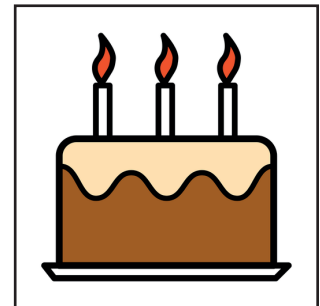

TARTA



CONCIENCIA FONÉMICA

R

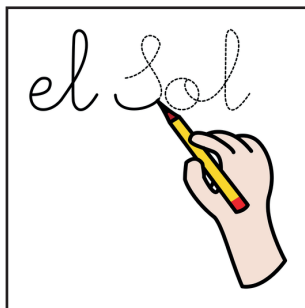
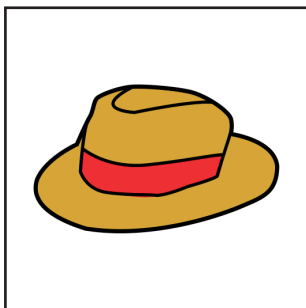
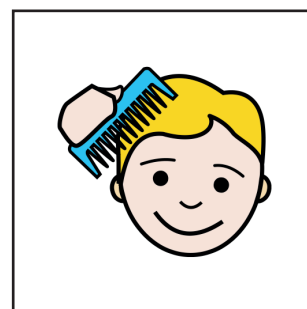
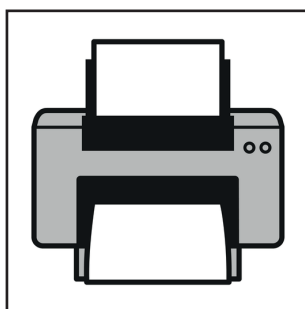
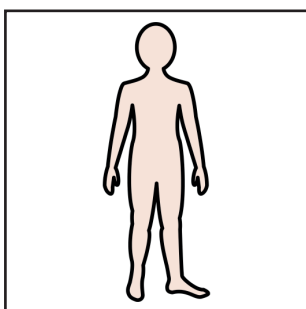
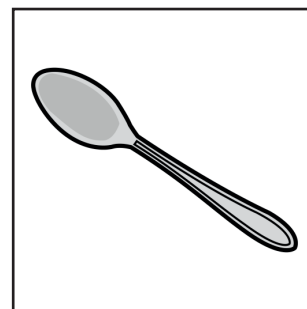
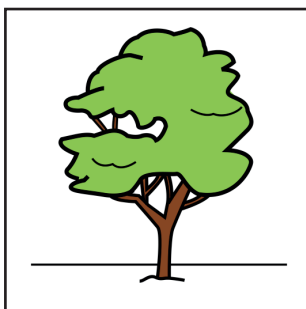

CONCIENCIA FONÉMICA

R

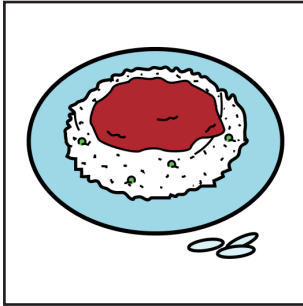

ARROZ

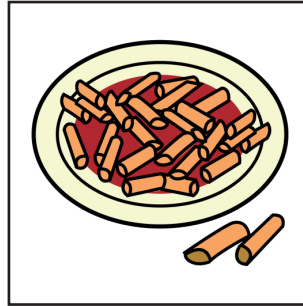

MACARRONES

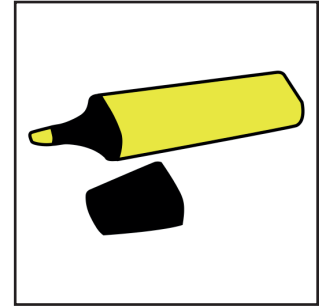

ROTULADOR



CARRO

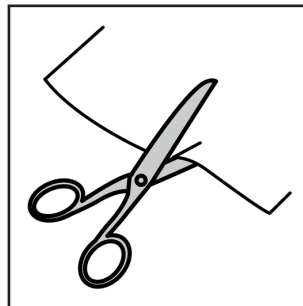

RECORTAR

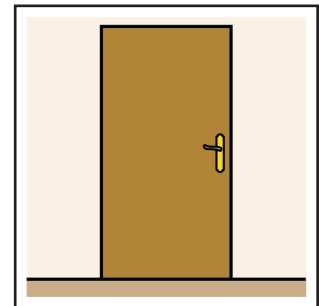

CERRADO



CARRERA

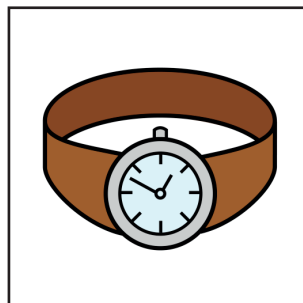

RELOJ

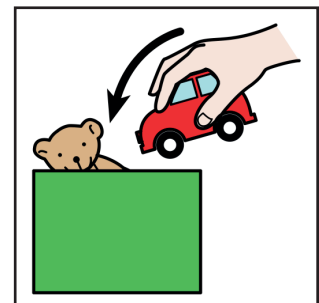

RECOGER



CONCIENCIA FONÉMICA

R

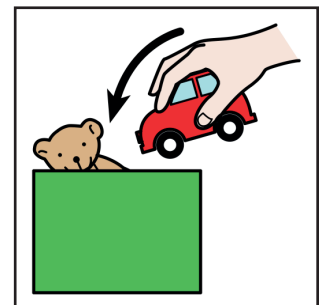
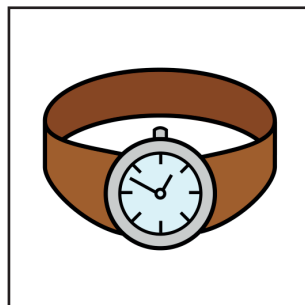
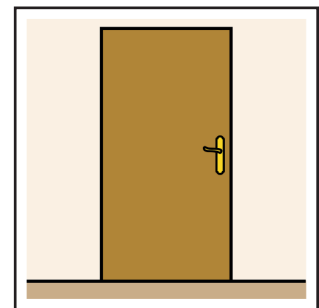
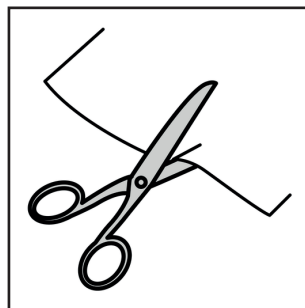
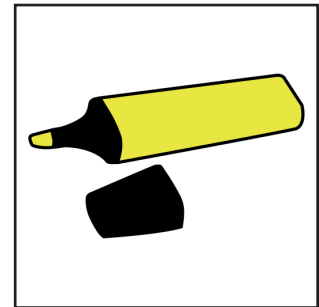
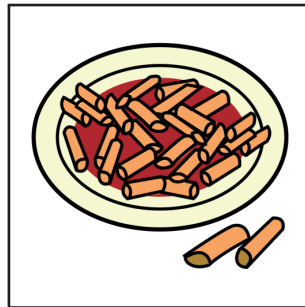
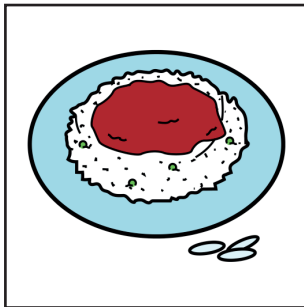

CONCIENCIA FONÉMICA

R

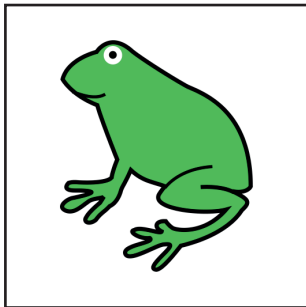

RANA

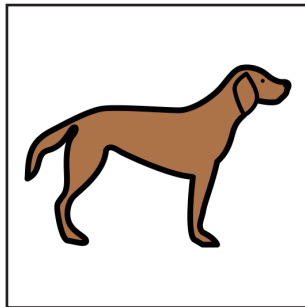

PERRO

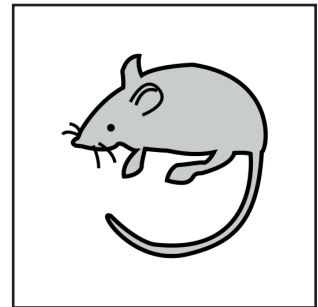

RATÓN

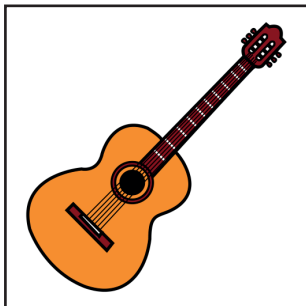

GUITARRA

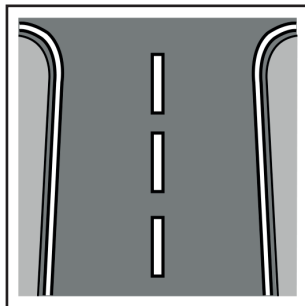

CARRETERA

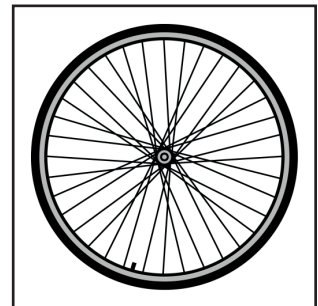

RUEDA



ROJO

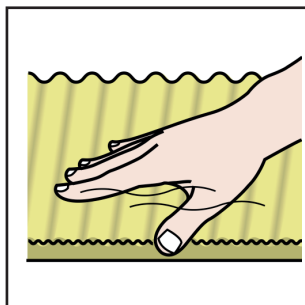

RUGOSO

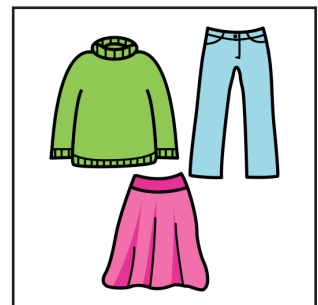

ROPA



CONCIENCIA FONÉMICA

R

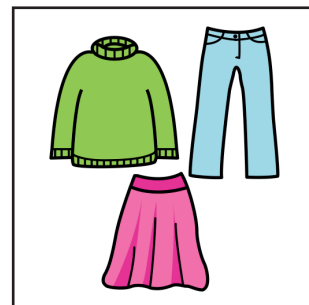
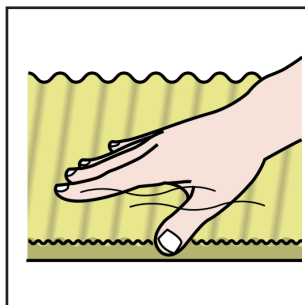
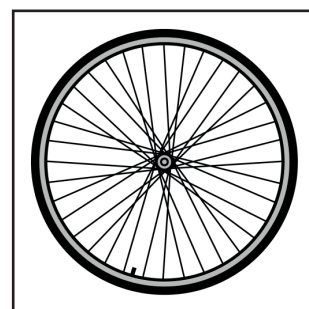
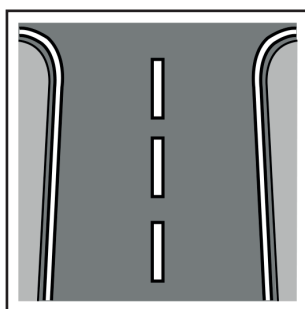
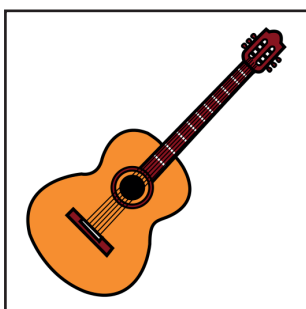
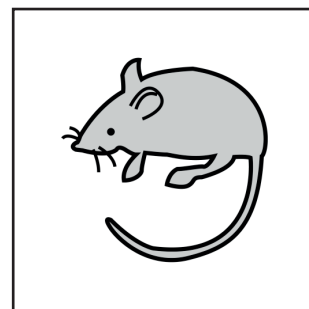
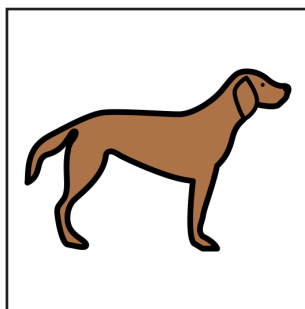
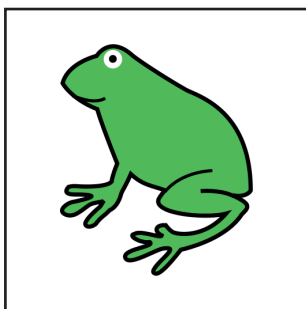

PICTOGRAMAS DE ARASAAC

Los símbolos utilizados son obra de Sergio Palao para CATEDU (<http://catedu.es/arasaac/>) que los publica bajo licencia Creative Commons.

Diseño y montaje: SUSANA PARÍS



**Fundación
Autismo Diario**